

# ACRYLIC WEATHERSHIELD INSTALLATION INSTRUCTIONS

SL1012  
P 1/2

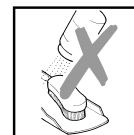

# ACRYLIC WEATHERSHIELD INSTALLATION INSTRUCTIONS

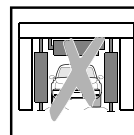
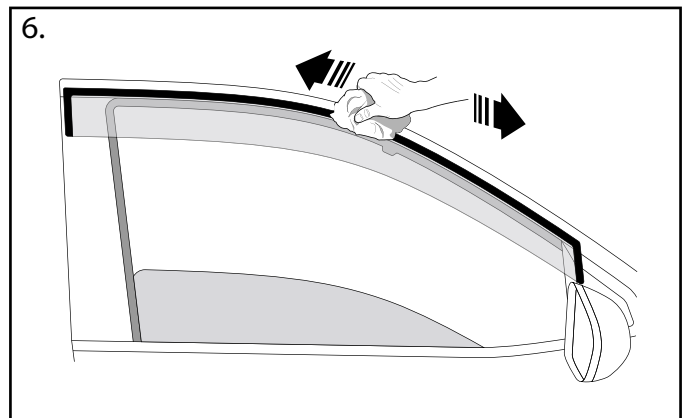
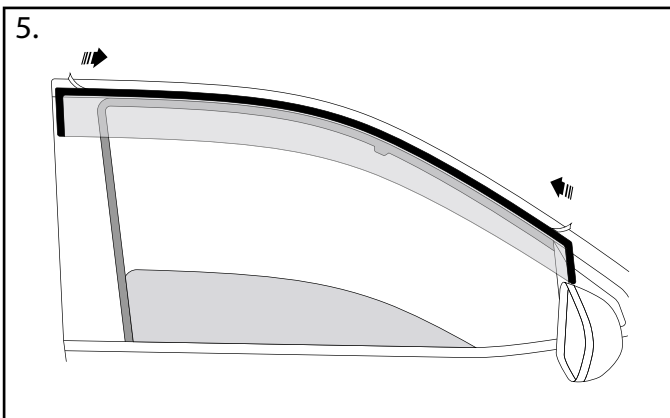
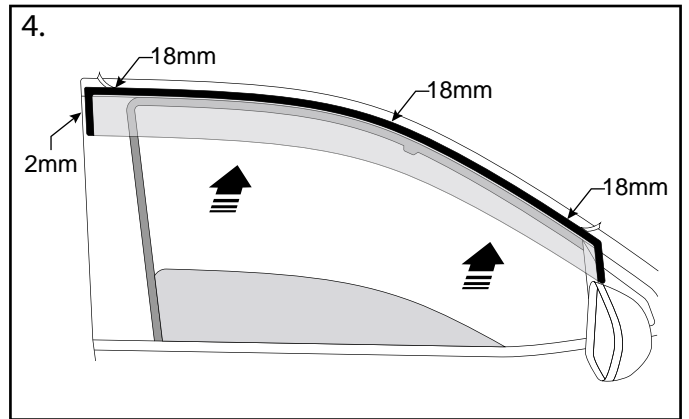
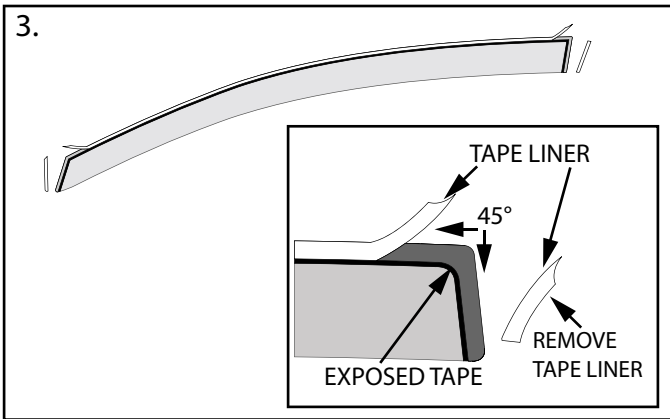
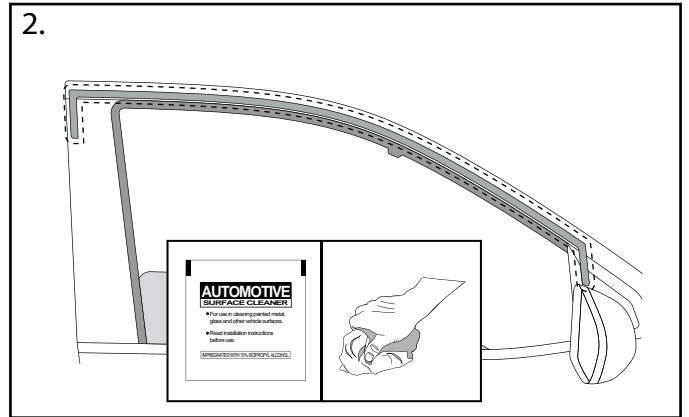
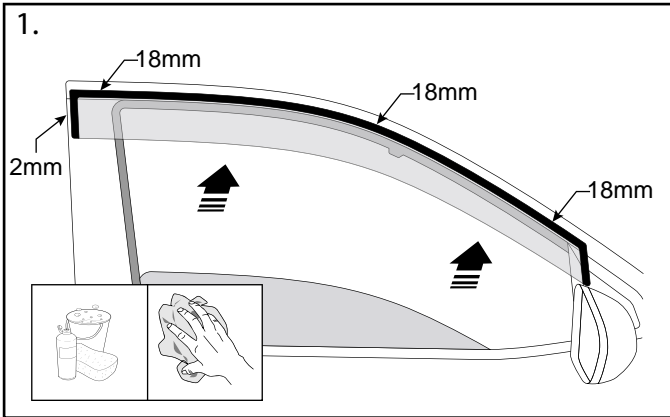
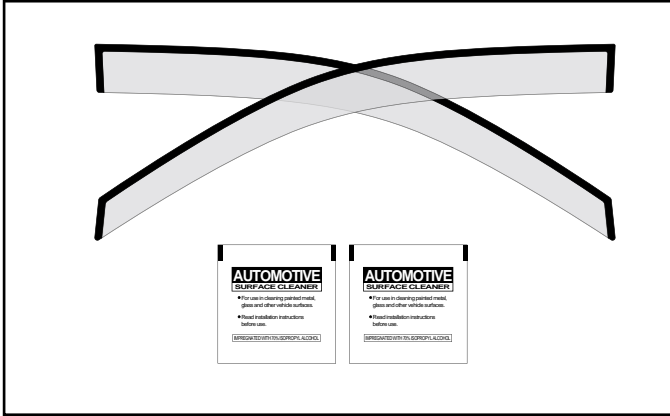